

## FS15 Series AC-DC Converter Compact Case(Power tank I)



PCB MOUNT TYPE



CHASSIS MOUNT TYPE

### Features

- UL, CB, CE, EMC Approved
- RoHS directive compliance
- Encapsulated, compact case
- High efficiency
- Universal input(AC85~264V or DC110~340V)
- Surface mounting technology
- Built in EMI filter
- Inrush current limit
- 67kHz fixed frequency
- Fixed output voltage
- Thermal shutdown(IC-Temp: 140°C Min.)
- Low output ripple & noise
- Isolated input-output(3kVAC)
- Output short circuit protection
- Over voltage protection(O.V.P.)
- Over current protection(O.C.P.)
- 2Years warranty

### Environmental

- Operating temperature range: -10°C~60°C
- Storage temperature range: -20°C~70°C
- Humidity: 20%~90%RH
- Vibration: 10-55Hz at 10G(98m/s<sup>2</sup>), 3minutes period, 60minutes each one X, Y and Z axis
- Impact: 50G(490m/s<sup>2</sup>), 11ms, once each
- Cooling method: natural air convection
- MTBF(MIL-HDBK-217F): 3.5\*10<sup>5</sup>hours

### Safety

- UL (UL60950, CSA C22.2 NO.60950)
- UL No: E227474
- CE(EN60950)/CB(IEC60950)-through TÜV
- \*To meet the standard of EN61204-3 class B, Use the external noise-filter between L and N (refer to manual)

### Description

The FS15 Series has universal AC input and there are 5 models with single output. And 2models with dual output. Compact size with high reliability are achieved. A built in EMI filter is reduced the noise level .

## FS15 Series AC-DC Converter Compact Case(Power tank I )

Electrical specifications		
INPUT	Voltage	AC85~264V (or DC 110~340V) 50/60Hz (note)
	Current	0.31A Max. @ 110VAC / 0.16A Max. @ 220VAC
	Frequency	47~440Hz Max. (50~60Hz typ.)
	Efficiency	75% Typ.
	Inrush current (at cold start)	30A Max. @ 120VAC. / 60A Max. @ 240VAC
	Leakage current	0.5mA Max. @ 110VAC / 0.75mA Max. @ 220VAC
OUTPUT	Voltage tolerance (accuracy)	±2% Max. ±3% Max(complementary dual).
	Ripple and noise	±1% Typ.
	Line regulation	±1% Typ.
	Load regulation	±1% Typ.@output1 / ±2% Typ.@output2,3
	Dynamic load regulation	±3% Typ.@output1
	Temperature regulation	±1% Typ.
	Rising time	400ms Max.
	Hold up time	10ms Min.

Protection circuit	
Over current protection	Works at over 105% of rating & recovers automatically
Over temperature protection	PWM IC-Temperature 140℃ Min. Latching, Recovering

Isolation specifications	
Isolation Resistance	DC 500V, 100MOhms Min.
Input-Output Isolation Voltage	AC 3KV, 1minute, 10mA.
Input-FG	AC 2KV, 1minute, 10mA.
Output-FG	AC 0.5KV, 1minute, 10mA.

General specifications	
Switching frequency	67kHz
Calculated MTBF	3.5*10 <sup>5</sup> hrs
Weight	100g or less

NOTE: For cases that conform various safety specifications(UL, CSA, CE, CB etc). It require input voltage and frequency range will be 100~240Vac, 50~60Hz.

**FS15 Series AC-DC Converter Compact Case(Power tank I )**

**Ordering information**

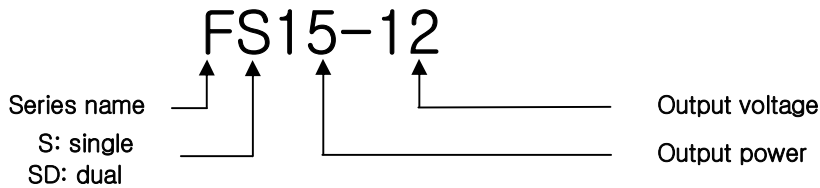

Input	Output1	Output2	Maximum power	Ripple & Noise	Efficiency typical	Model number
AC85~264V or DC110~340V	3.3V@3.0A		9.9W	80mVp-p	71%	FS15-3R3
	5V@3.0A		15.0W	80mVp-p	75%	FS15-5
	12V@1.3A		15.6W	120mVp-p	78%	FS15-12
	15V@1.0A		15.0W	150mVp-p	78%	FS15-15
	24V@0.65A		15.6W	200mVp-p	78%	FS15-24
	+12V@0.65A	-12V@0.65A	15.6W	120/120mVp-p	75%	FSD15-1212
	+15V@0.50A	-15V@0.50A	15.0W	150/150mVp-p	75%	FSD15-1515

**Pin assignments**

- |                      |                    |
|----------------------|--------------------|
| <b>Single output</b> | <b>Dual output</b> |
| 1. FG                | 1. FG              |
| 2. AC(N)             | 2. AC(N)           |
| 3. AC(L)             | 3. AC(L)           |
| 4. No pin            | 4. No pin          |
| 5. Output1           | 5. Output1         |
| 6. No pin            | 6. GND             |
| 7. GND               | 7. Output2         |
| 8. No pin            | 8. No pin          |

**Derating curve**

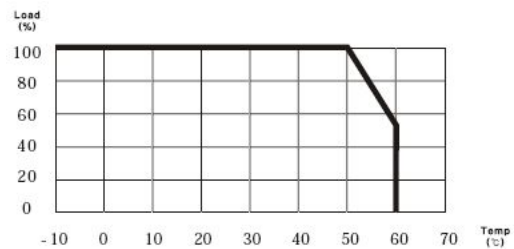

**Dimensions**

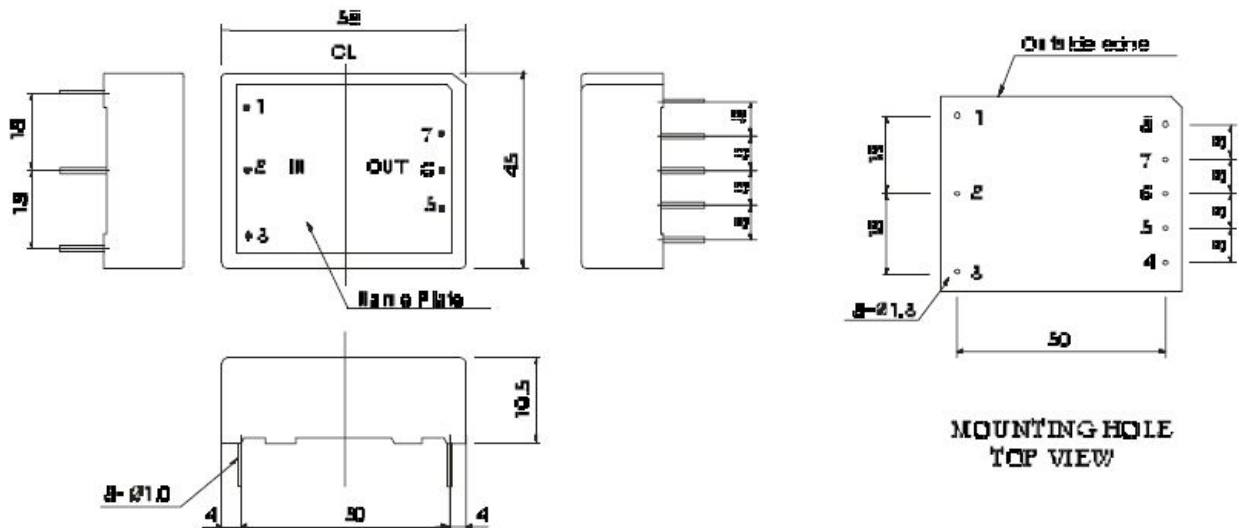

**NOTES**

1. All dimensions are mm.
2. Weight: 100g or less

# FS15 Series AC-DC Converter Compact Case(Power tank I)

## Inrush Current

### TEST CONDITION

- 240Vac input
- Full load output
- PHASE 90° input start, current measure

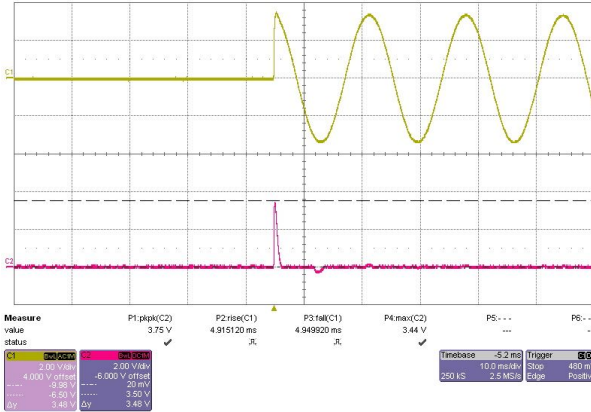

FS15-3R3 17.4A

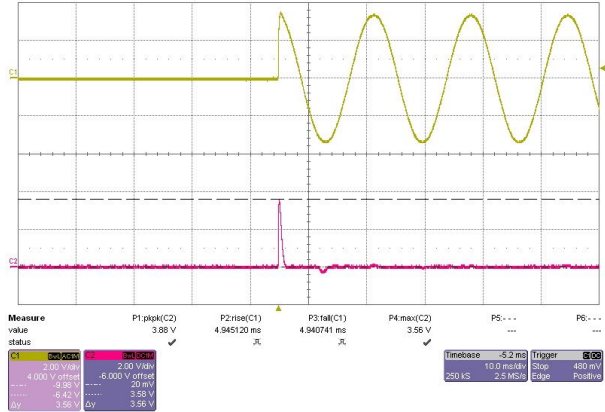

FS15-5 17.8A

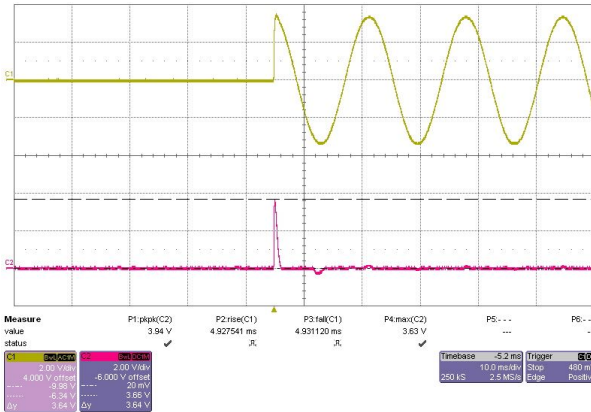

FS15-12 18.2A

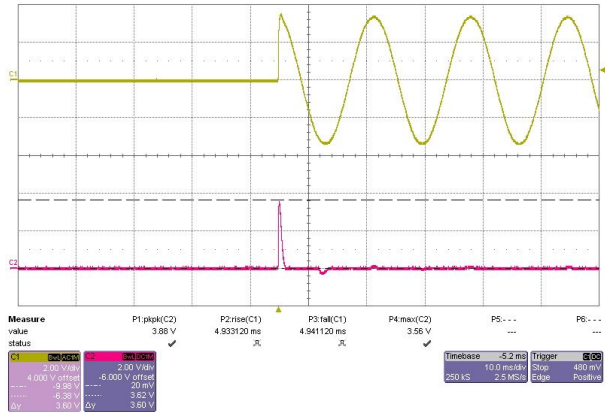

FS15-15 18.0A

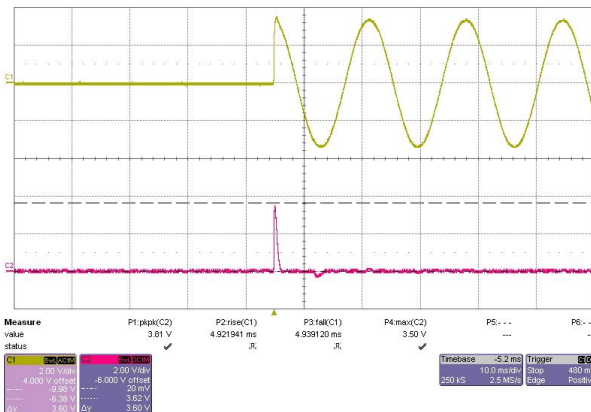

FS15-24 18.0A

Inrush current concerns wrong to fuse, input rectifier, power-switch, circuit break and parts. It degrades the another circuit voltage and occurs system error. If you defuse inrush current.

You add NTC or Inrush current limiter to external circuit.

High rating voltage input

Max 30A @ 120Vac

Max 60A @ 240Vac

# FS15 Series AC-DC Converter Compact Case(Power tank I)

## Rising Time

### TEST CONDITION

- 100Vac Input
- Full Load Output
- Output Voltage 10% ~ 90% Rising Time Measure

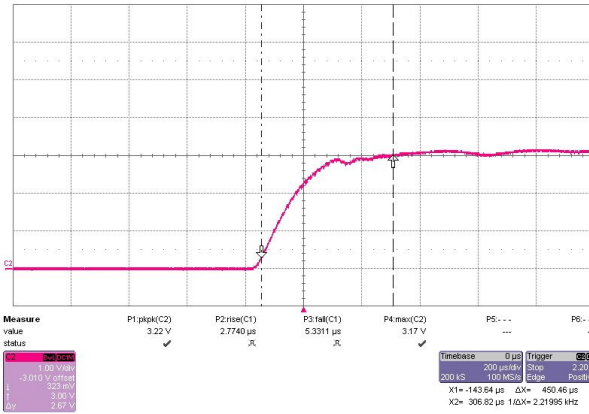

FS15-3R3 0.450mS

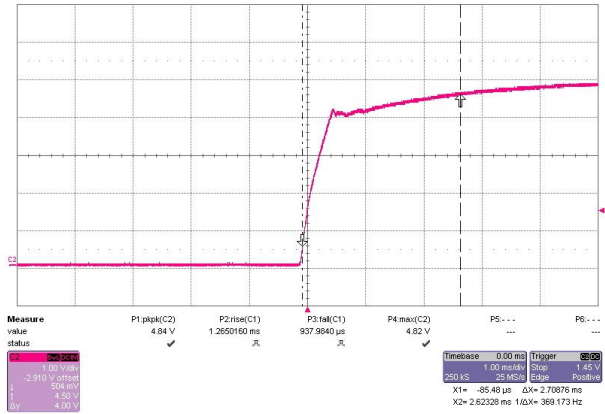

FS15-5 2.71mS

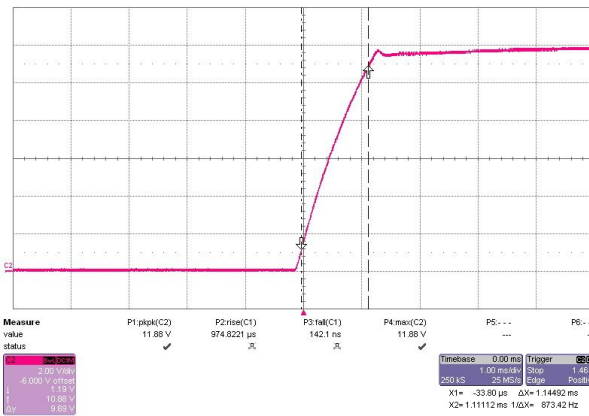

FS15-12 1.15mS

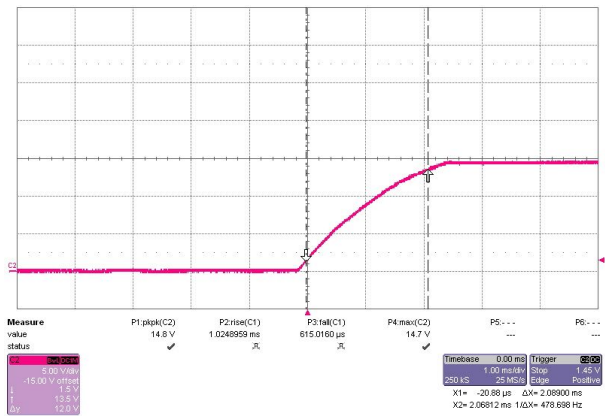

FS15-15 2.09mS

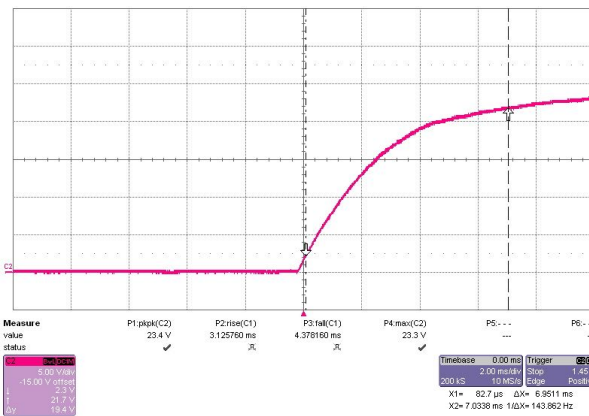

FS15-24 6.95mS

Max 100ms between output voltage 10%~90%



# FS15 Series AC-DC Converter Compact Case(Power tank I )

## Hold up Time

### TEST CONDITION

- 100Vac Input
- Full Load Output
- When Input off Phase 0° or 360°, Output Voltage off Time Measure

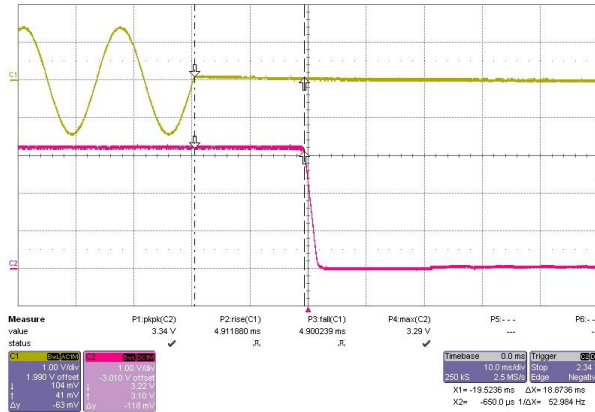

FS15-3R3 18.87mS

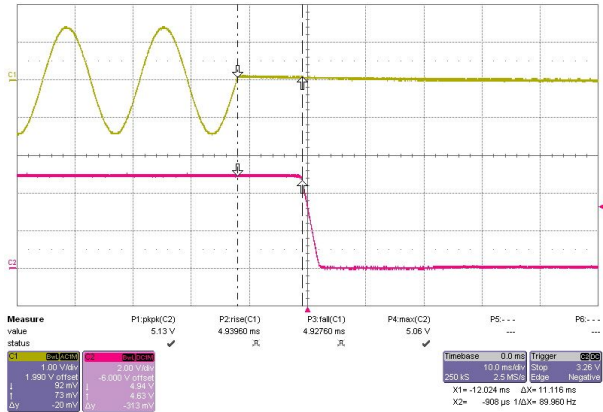

FS15-5 11.12mS

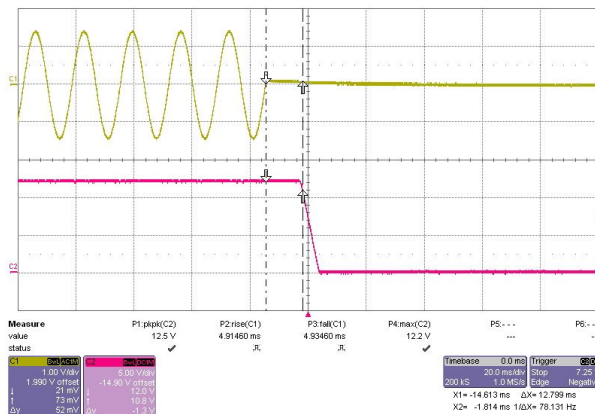

FS15-12 12.80mS

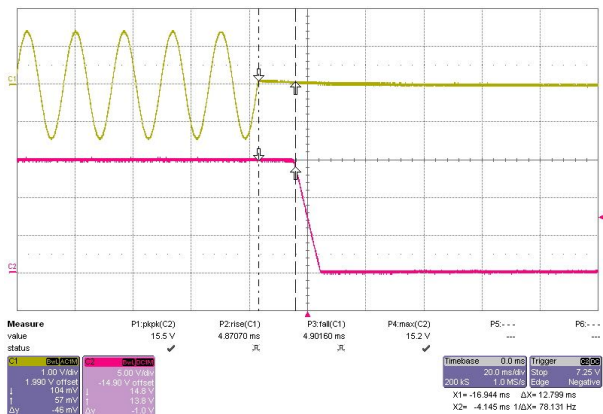

FS15-15 12.80mS

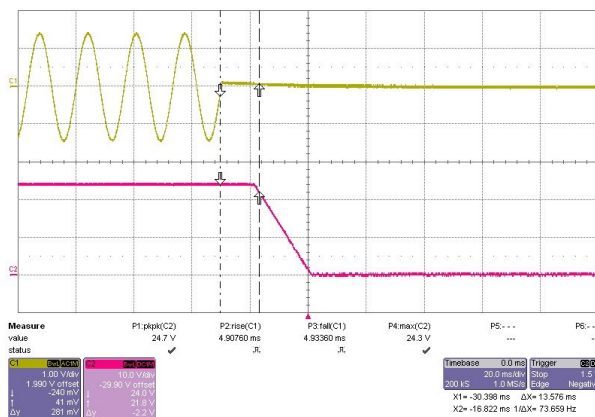

FS15-24 13.58mS

The amount of time that a power supply's output-voltage remains within the specified-voltage ranges after it's input voltage interrupts. Low rating voltage Minimum 10ms @100Vac input

# FS15 Series AC-DC Converter Compact Case(Power tank I)

## Start up Time

### TEST CONDITION

- 100Vac Input
- Full Load Output
- When Input on Phase 360°, Output Voltage 100% rise Time Measure

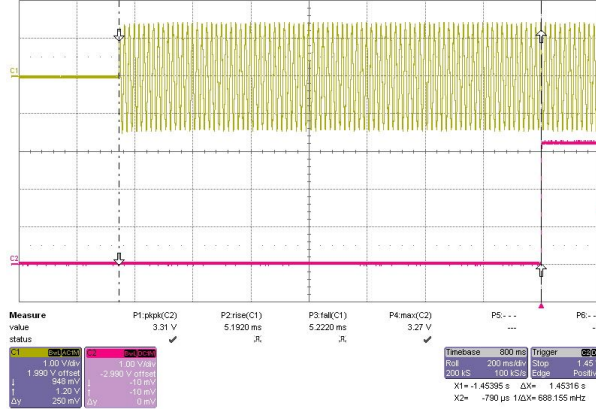

FS15-3R3 1.45S

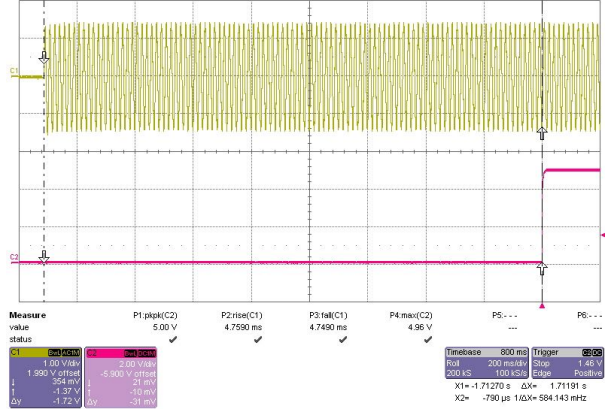

FS15-5 1.71S

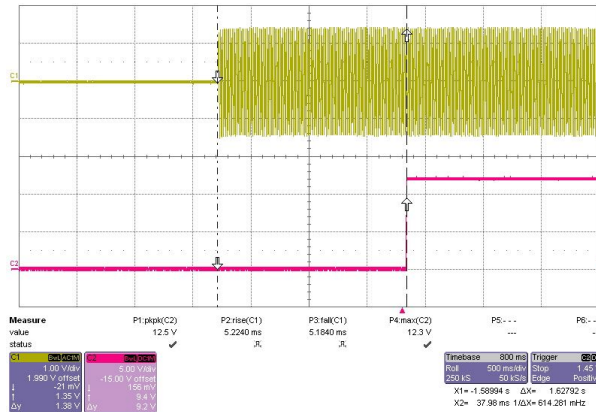

FS15-12 1.63S

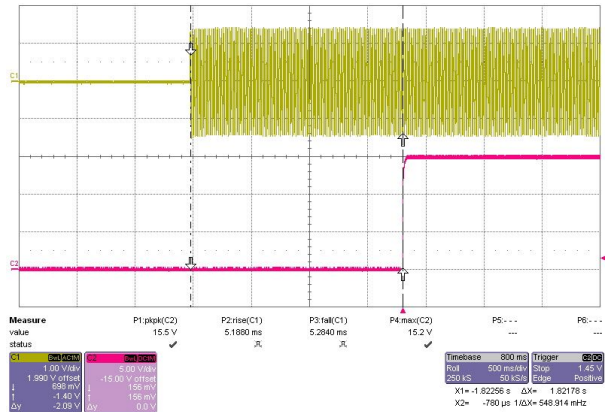

FS15-15 1.82S

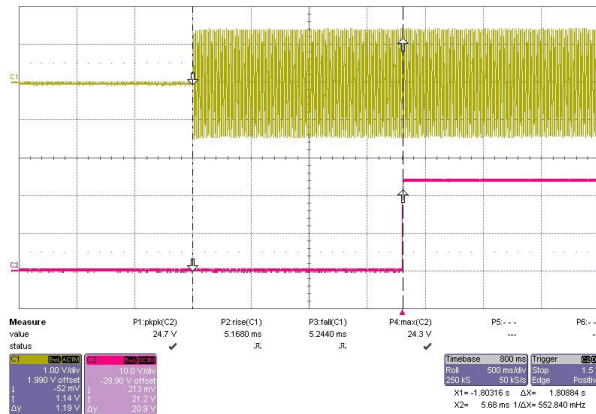

FS15-24 1.81S

Amount of delay time and rise time. After input-voltage injects.

## FS15 Series AC-DC Converter Compact Case(Power tank I)

### Dynamic Load Regulation

#### TEST CONDITION

- 100Vac Input
- 0% Load ~ 100% Load Output
- Freq. : 100Hz , - Duty : 0.5

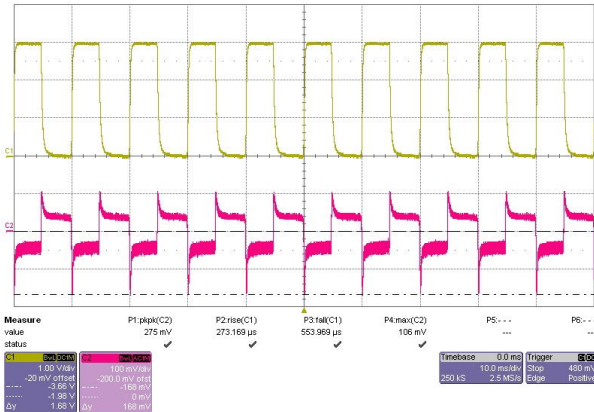

FS15-3R3 168mV

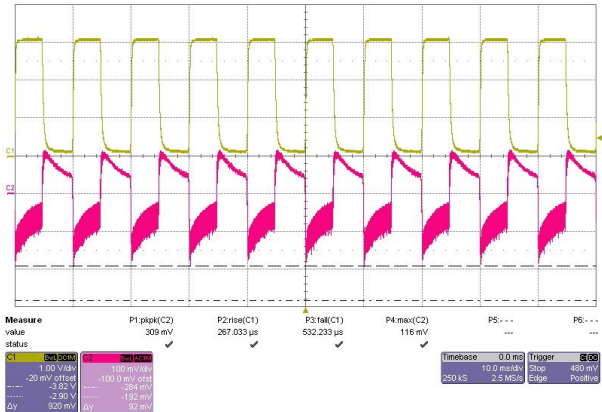

FS15-5 192mV

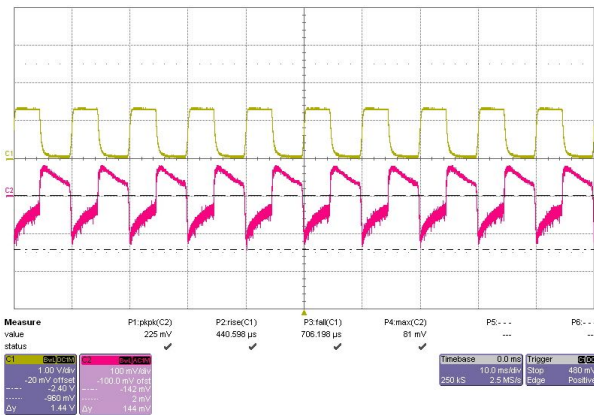

FS15-12 142mV

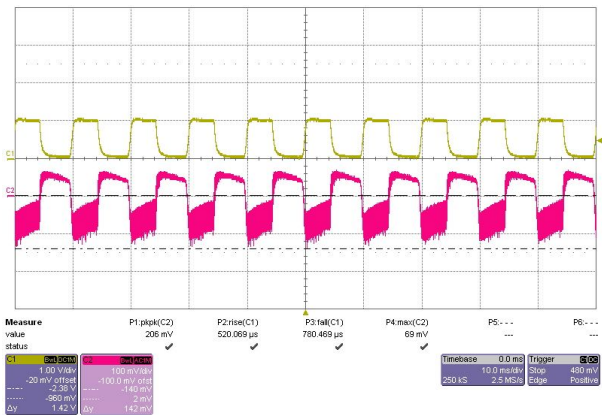

FS15-15 140mV

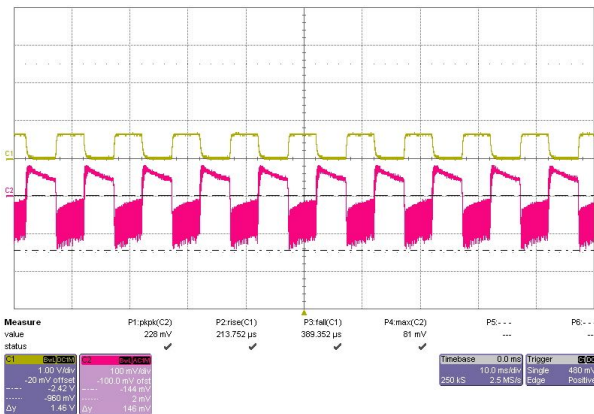

FS15-24 144mV

Considerate slew rate and frequency within  $\pm 3\%$  output voltage value. Except FS15-3R3 is within  $\pm 5\%$  output voltage value.



FS15 Series AC-DC Converter Compact Case(Power tank I)

Over Shoot

TEST CONDITION

- 240Vac Input
- Full Load Output

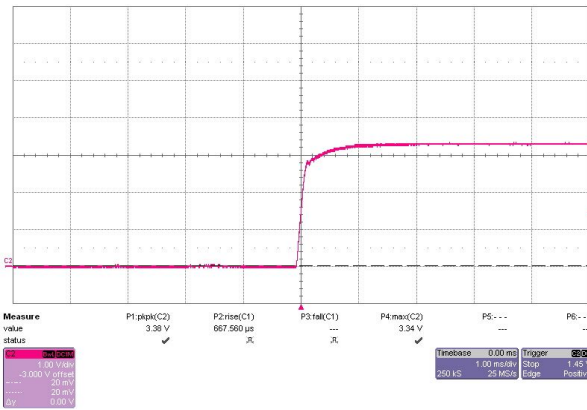

FS15-3R3 0V

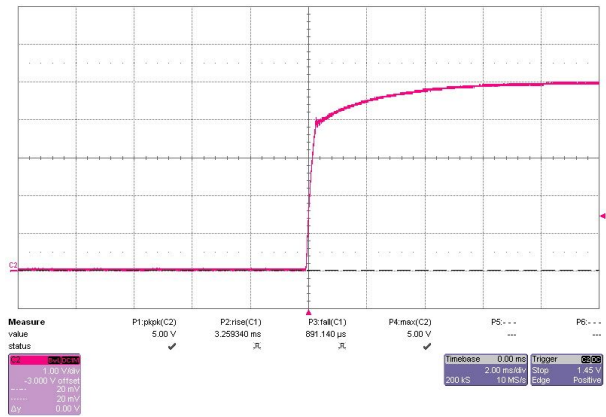

FS15-5 0V

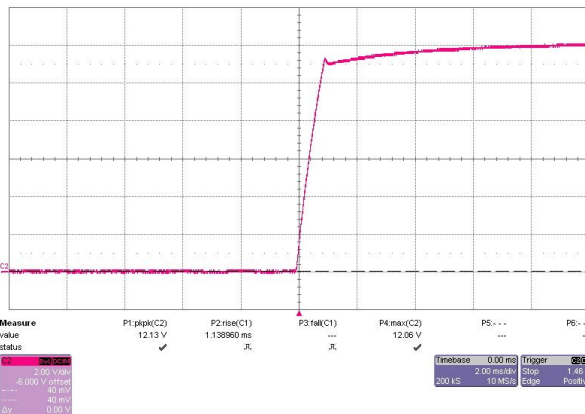

FS15-12 0V

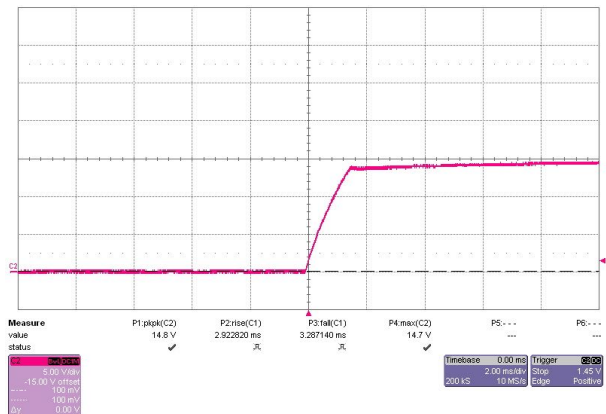

FS15-15 0V

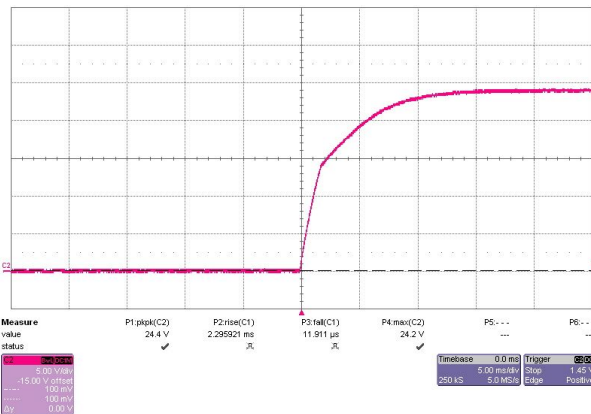

FS15-24 0V

When turn-on, the output overshoot voltage shall not exceed 5% of normal Voltage value no Load or full Load connected.

FS15 Series AC-DC Converter Compact Case(Power tank I)

Output Ripple & Noise

TEST CONDITION

- 100Vac Input
- Full Load Output
- Ele-cap(47uF)and Ceramic-cap(104), Output Terminal

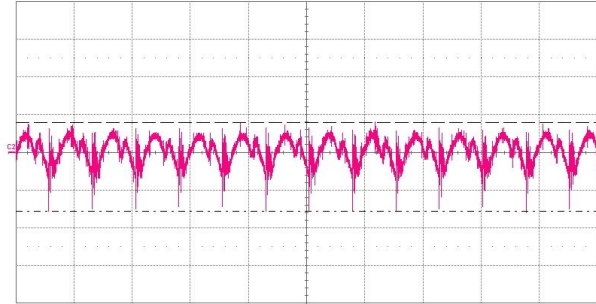

FS15-3R3 46.8mVpp

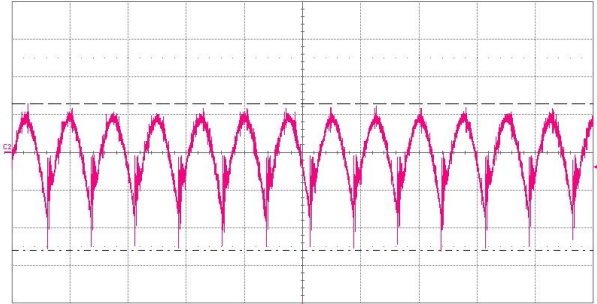

FS15-5 77.8mVpp

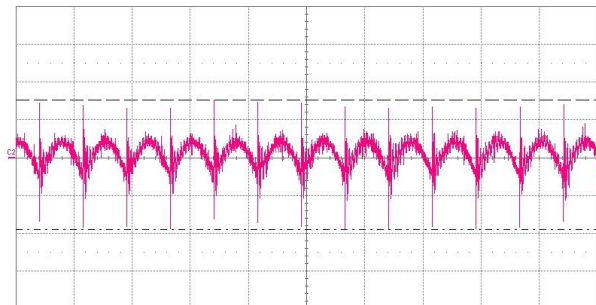

FS15-12 68.6mVpp

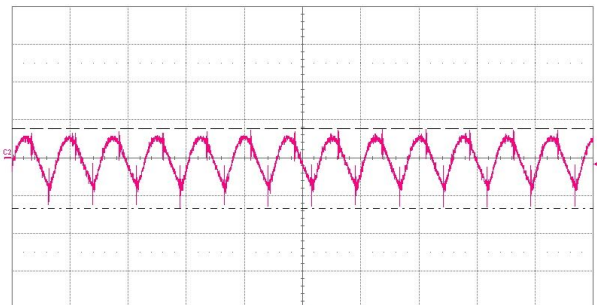

FS15-15 106.0mVpp

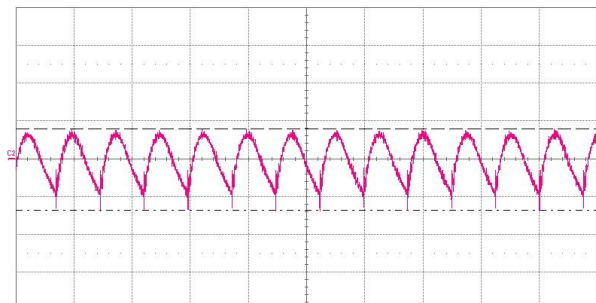

FS15-24 108.0mVpp

\*Ripple & Noise: Oscilloscope bandwidth 20MHz.  
The length of the output line should be shorter than 1meter and it needs to be twisted.

FS15 Series AC-DC Converter Compact Case(Power tank I )

Efficiency Curve(Load Variation)

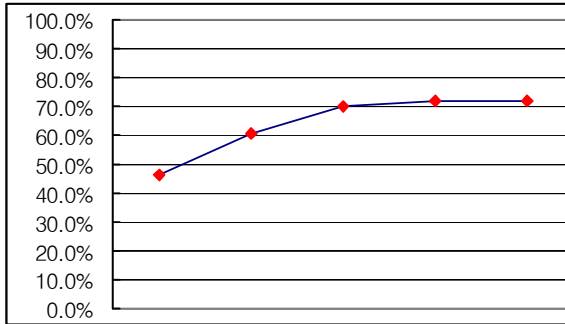

Load(%)	10	25	50	75	100
Eff(%)	46.26	60.48	69.90	72.08	71.88

FS15-3R3 / 3.3V 3.0A

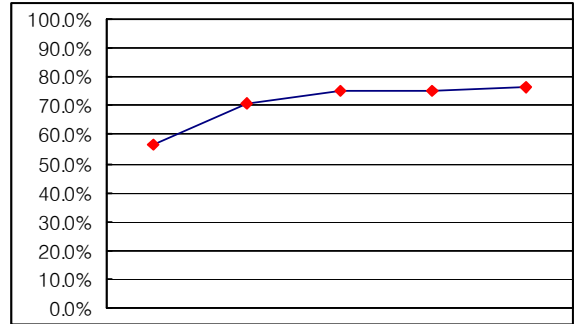

Load(%)	10	25	50	75	100
Eff(%)	56.72	70.50	75.00	75.40	76.22

FS15-5 / 5V 3.0A

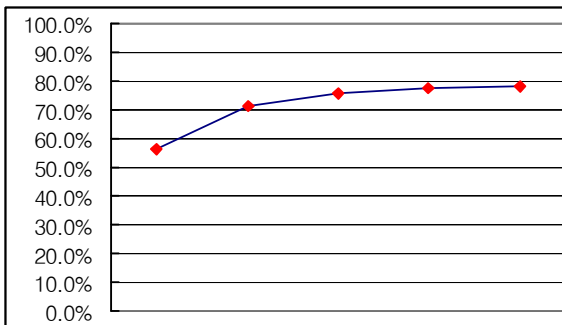

Load(%)	10	25	50	75	100
Eff(%)	56.07	71.49	75.91	77.43	78.01

FS15-12 / 12V 1.3A

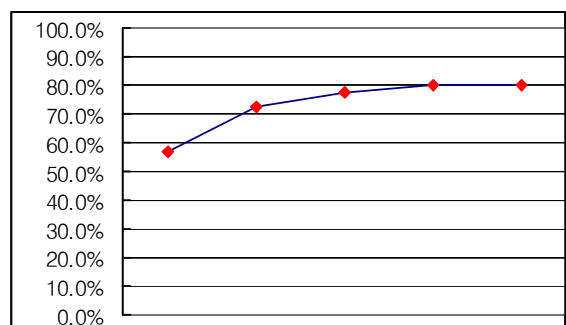

Load(%)	10	25	50	75	100
Eff(%)	56.63	72.29	77.78	79.69	79.86

FS15-15 / 15V 1.0A

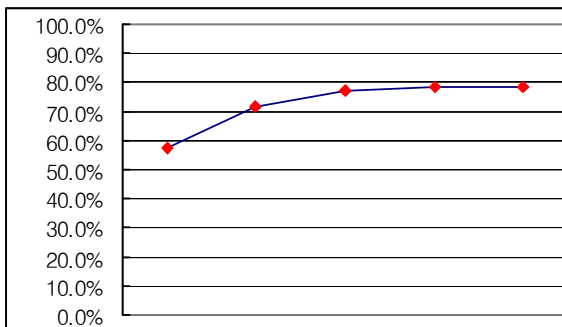

Load(%)	10	25	50	75	100
Eff(%)	57.50	71.45	77.39	78.11	78.40

FS15-24 / 24V 0.65A

Input 220Vac, Variation of efficiency, from minimum load to maximum load.

## FS15 Series AC-DC Converter Compact Case(Power tank I )

### Efficiency Curve(Input Voltage Variation)

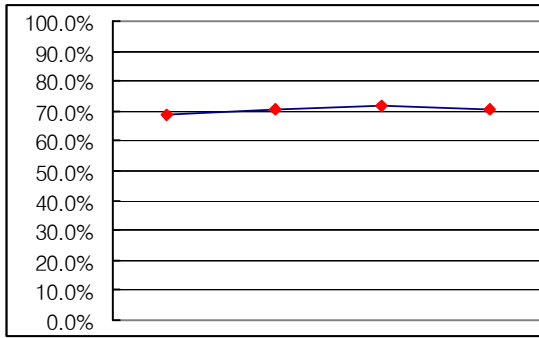

V in(V)	85	110	220	264
Eff(%)	68.52	70.49	71.77	70.44

FS15-3R3 / 3.3V 3.0A

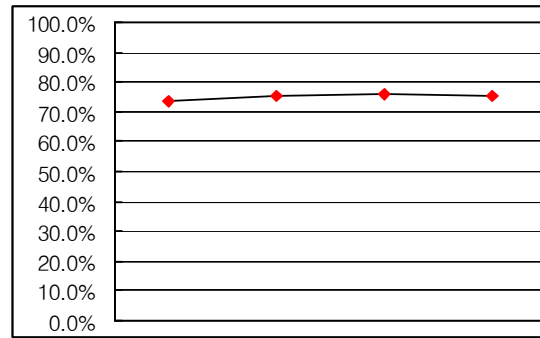

V in(V)	85	110	220	264
Eff(%)	73.42	75.61	76.22	75.57

FS15-5 / 5V 3.0A

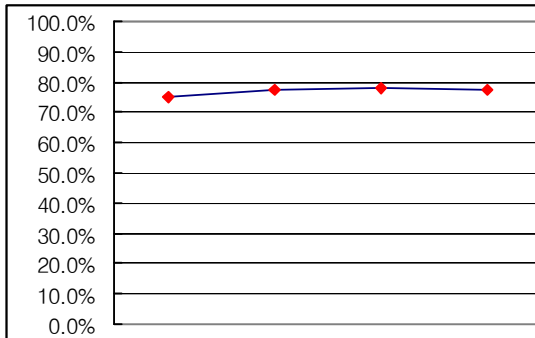

V in(V)	85	110	220	264
Eff(%)	75.22	77.48	77.82	77.29

FS15-12 / 12V 1.3A

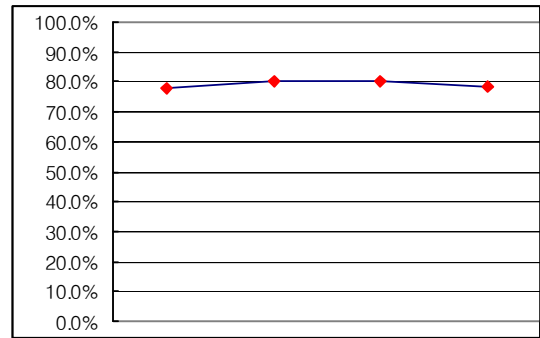

V in(V)	85	110	220	264
Eff(%)	77.73	80.19	80.02	78.30

FS15-15 / 15V 1.0A

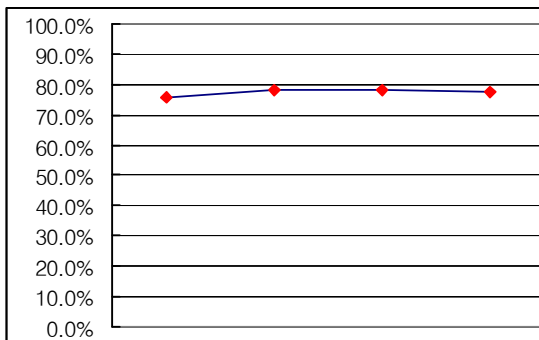

V in(V)	85	110	220	264
Eff(%)	75.45	77.90	78.21	77.55

FS15-24 / 24V 0.65A

Variation of Efficiency, from Minimum input  
Voltage to Maximum input Voltage

## FS15 Series AC-DC Converter Compact Case(Power tank I )

### Electro Magnetic Interference Application.

FS15 Series is needs to reduce Electromagnetic Interference, use the external L-C noise filter at the input of the Converter.

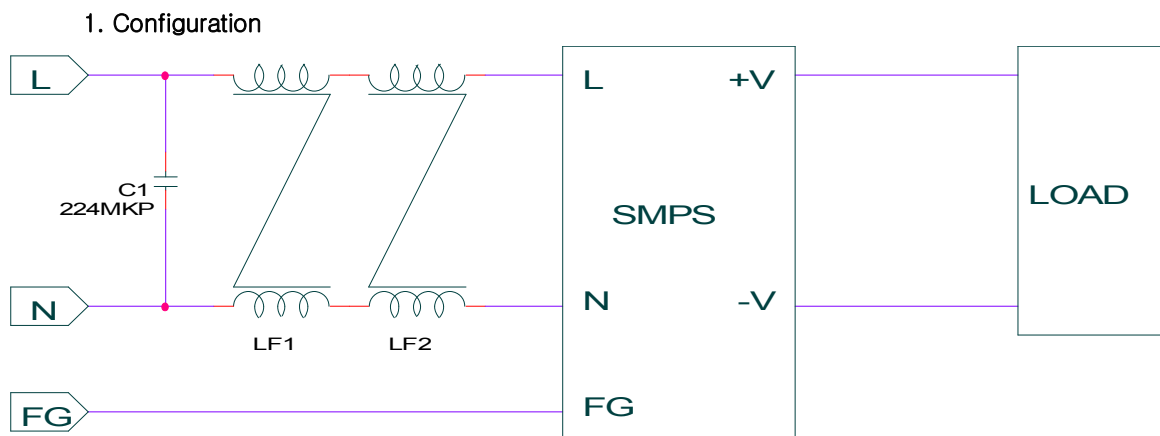

### 2. Components

C1 = 220nF / 275Vac, X2 Capacitor

LF1 = 20mH Common Mode Line Filter, Toroidal core  $\phi$ 14.0mm

LF2 = 20mH Common Mode Line Filter, Toroidal core  $\phi$ 14.0mm



## FS15 Series AC-DC Converter Compact Case(Power tank I )

### Calculating Reliable Values of MTBF

#### 1. Calculating method

Calculated based on part count reliability projection of MIL-HDBK-217F Individual failure rates  $\lambda_g$  is given to each part and MTBF (Mean Time Between Failure) is calculated by the count of each part.

<Formula>:

$$MTBF = 1 / \lambda_{equip} = 1 / \left( \sum_{i=1}^n N_i (\lambda_i \Pi Q)_i \right) * 10^6 \text{ (Hours)}$$

$\lambda_{equip}$  : Total Equipment Failure Rate (Failure/10<sup>6</sup>Hours)

$\lambda_G$  : Generic Failure Rate for The ith Generic Part (Failure/ 10<sup>6</sup>Hours)

$\Pi Q$  : Generic Quality Factor for The ith Generic Part ( $\Pi Q=1$ )

$N_i$  : Quantity of ith Generic Part

$n$  : Number of Different Generic Part Categories

#### 2. MTBF Values

MTBF  $\approx$  364,962 (Hours)

PART	Num.	Failure Rate	Failure Rate*n	Remark
	n	$\lambda_G(F/T)$	$\lambda_G \times n(F/T)$	
Logic IC	1	0.03600	0.03600	Separate
Transistor, FET	1	0.49500	0.49500	Separate
Diode Fast Recovery	2	0.12650	0.25300	
Diode General Purpose	1	0.01980	0.01980	
Diode Switching	1	0.00517	0.00517	
Diode Bridge	1	0.01980	0.07920	*4
Voltage Regulator	1	0.02400	0.02400	
Photo-coupler	1	0.14850	0.14850	
Thermister	1	0.01400	0.01400	
Capacitor-ele	5	0.01900	0.09500	
Capacitor-film	1	0.00700	0.00700	
Capacitor-ceramic	4	0.02600	0.10400	
Capacitor-MLCC	3	0.05300	0.15900	
Choke coil	1	0.00022	0.00022	
Switching trans	1	0.00420	0.00420	
Line Filter	1	0.00440	0.00440	
Resistor Chip	13	0.01600	0.20800	
Connector	5	0.05200	0.26000	
Reflow soldering	48	0.00014	0.00672	
Flow soldering	56	0.00780	0.43680	
PCB	1	0.37000	0.37000	
Fuse	1	0.01000	0.01000	
Total Equipment Failure Rate $\lambda_G \times n(F/T)$			2.74001	
MTBF = $10^6 / \lambda_G(F/T)$			364962.1717	

## FS15 Series AC-DC Converter Compact Case(Power tank I )

Reliability Specification	Standard	Remarks
Dry heat	IEC60068-2-2	
Cold	IEC60068-2-1	
Thermal shock	IEC60068-2-14	
Temperature, humidity cycle	IEC60068-2-30, IEC60068-2-38	
Vibration	IEC 60068-2-6	
Mechanical shock	IEC 60068-2-27	
Electrostatic Discharge immunity	IEC 61000-4-2	
Immunity to radio frequency EM-fields	IEC 61000-4-3	
Electrical fast transient/burst immunity	IEC 61000-4-4	
Surge immunity	IEC 61000-4-5	
B10 Life test	B10 Life is the time by which 10% of the product population will get failed	

## FS15 Series AC-DC Converter Compact Case(Power tank I)

### Instruction manual

#### 1. Basic connection

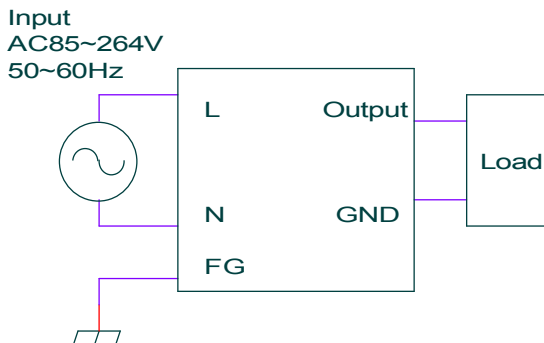

#### NOTE:

A: For safety as well as improved noise, ensure secure connection of the FG terminal to the ground terminal of the equipment.

B: To avoid excessive voltage drop and for improved noise, and short and thick wire should be used to connect the load. Length below 50Cm & wire thickness of 4.0A/mm<sup>2</sup> are recommended for reducing wire loss when wire connection is necessary.

#### 2. Parallel Operation

This supply can be operated the following ways.

Choose a diode in accordance with voltage, power dissipation and heat radiation.

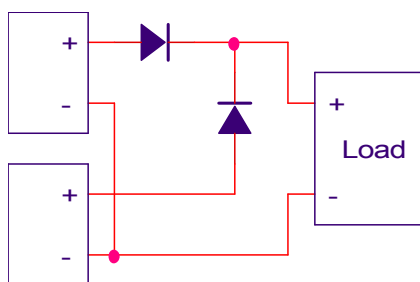

- Voltage :  $V > V_o \times 3$
- Current :  $I > I_o \times 3$
- Design a proper heat sink according to power loss at diode (  $P_w = V_F \times I_o$  )

- Use a schottky or fast recovery diode this has a low VF.

#### 3. Series Operation

Choose a diode in accordance with voltage, power dissipation and heat radiation.

- Voltage :  $V > V_o \times 3$
- Current :  $I > I_o \times 3$
- Design a proper heat sink according to power loss at diode (  $P_w = V_f \times I_o$  ).
- Use a schottky or fast recovery diode this has a low VF.

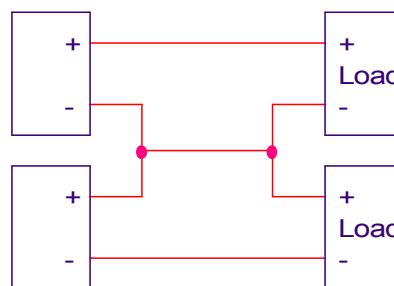
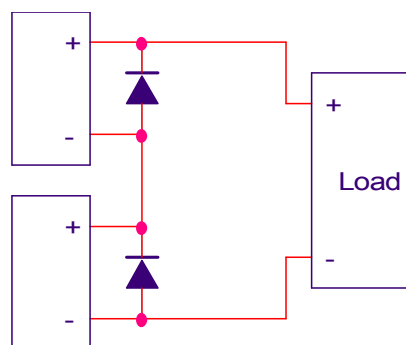

#### 4. Over Current Protection

The FS15 Series is equipped with an over current protection circuit. When the short or overload condition is removed, the output will automatically recover. This setting is fixed and cannot be varied externally. If the short or overload condition continues, the power module could be damaged due to the heat condition.

## FS15 Series AC-DC Converter Compact Case(Power tank I)

### 5. Over Voltage Protection

FS15 series are equipped with an over-voltage protection circuit by zener diode. If zener diode is opened, Vcc rise up, it becomes possible to implement an over voltage protection. Ratch on mode. If zener diode is short, output is shorted.

It becomes possible to implement a short circuit Protection.

### 6. Over Temperature Protection

Temperature protection is provided by a precision analog circuit that turns the output MOSFET off when the junction temperature exceeds the thermal shutdown temperature (140°C Minimum). When the junction temperature cools to below the hysteretic temperature, normal operation resumes providing automatic recovery.

### 7. Line Regulation

Maximum line regulation is maximum output voltage change when the input volt is slowly varied with in the input voltage range.

### 8. Load Regulation

Maximum load regulation is maximum output voltage value change when varying the load current slowly within the standard output current range.

### 9. Isolation Resistance

The isolation resistance is more than 100MΩ at 500VDC when tested with DC isolation between the output and the case. Make sure that during testing, the isolation tester does not produce a high pulse when the applied voltage is varied. Ensure that the tester is fully discharged after the test.

### 10. Withstand Voltage

FS15 series are designed to withstand 3KVAC (10mA) 1 minute between input output for the withstand voltage test, 2KVAC(10mA) 1minute between input-FG , and 500VAC(10mA)1 minute between output-FG. The applied voltage must be increased gradually from zero to the testing value, and then decreased gradually at shut down.

Especially stay away from use of a timer. Where a pulse of several times the applied voltage can be generated.

#### INPUT-OUTPUT

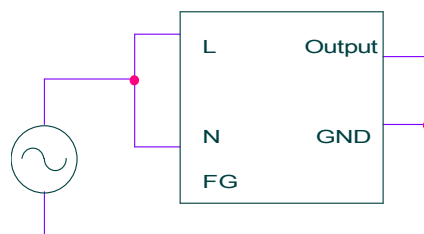

3KVAC, one minute, 10mA

#### INPUT-FG

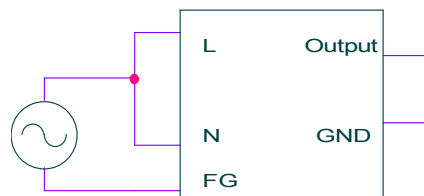

2KVAC, one minute, 10mA

#### OUTPUT-FG

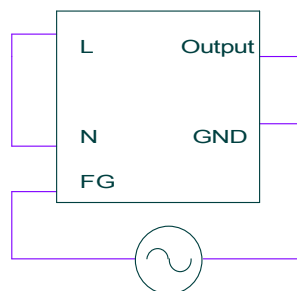

500VAC, one minute, 10mA

## FS15 Series AC-DC Converter Compact Case(Power tank I )

### 11. Block Diagrams

Circuit topology : Fly-back

Switching frequency : 67KHz(fixed)

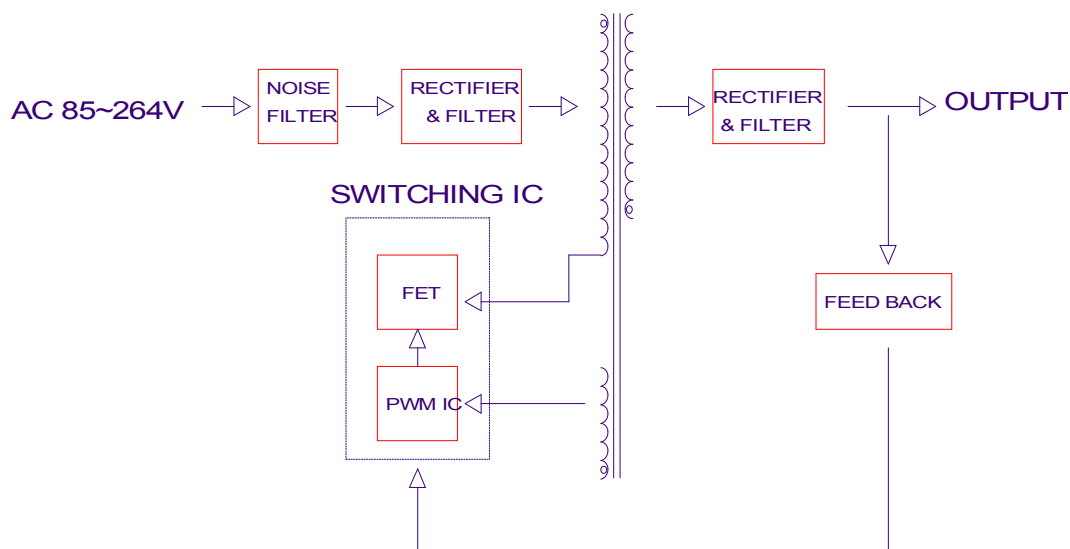

**POWERPLAZA**

Power Plaza co., Ltd

#1401, Daeryung Techno Town 493-6

Gasam-Dong, Kumchon-Gu, Seoul, 153-774,

Korea

Tel: 82\_2\_855\_4955

Fax: 82\_2\_855\_4954

E-mail: sales@powerplaza.co.kr